

Lateral Bracing of Gable Studs Applied to One Ply of Multiple Ply Truss

ASCE 7-16: 120 mph Wind Speed, 30' Mean Height, Enclosed, Exposure C, $K_{zt} = 1.00$

H Up to 4'6" - no stud bracing required.

H Greater than 4'6" up to 7'6" :
provide a 2x6 stiffback at mid-height and brace stiffback to roof diaphragm every 6'0" (see detail below).

H Greater than 7'6" up to 12'0" max:
provide a 2x6 stiffback at mid-height and brace to roof diaphragm every 4'0" (see detail below).

** Optional 2x L-reinforcement attached to stiffback with 10d box or gun (0.128" x 3", min.) nails @ 6" o.c.

Lateral chord bracing requirements
Top: Continuous roof sheathing
Bot: Continuous ceiling diaphragm

Refer to the Building Designer for conditions not addressed by this detail.

Minimum Stud Plate Size

Stud Length	Plate Size
Less than 4'0"	1X4 or 2X3
Greater than 4'0" and up to 11'6"	2X4
Greater than 11'6"	3X4

⊕ Refer to Engineered Truss Design for peak, splice, web, and heel plates.

⊗ If gable vertical plates overlap, use a single plate that covers the total area of the overlapped plates to span the web.

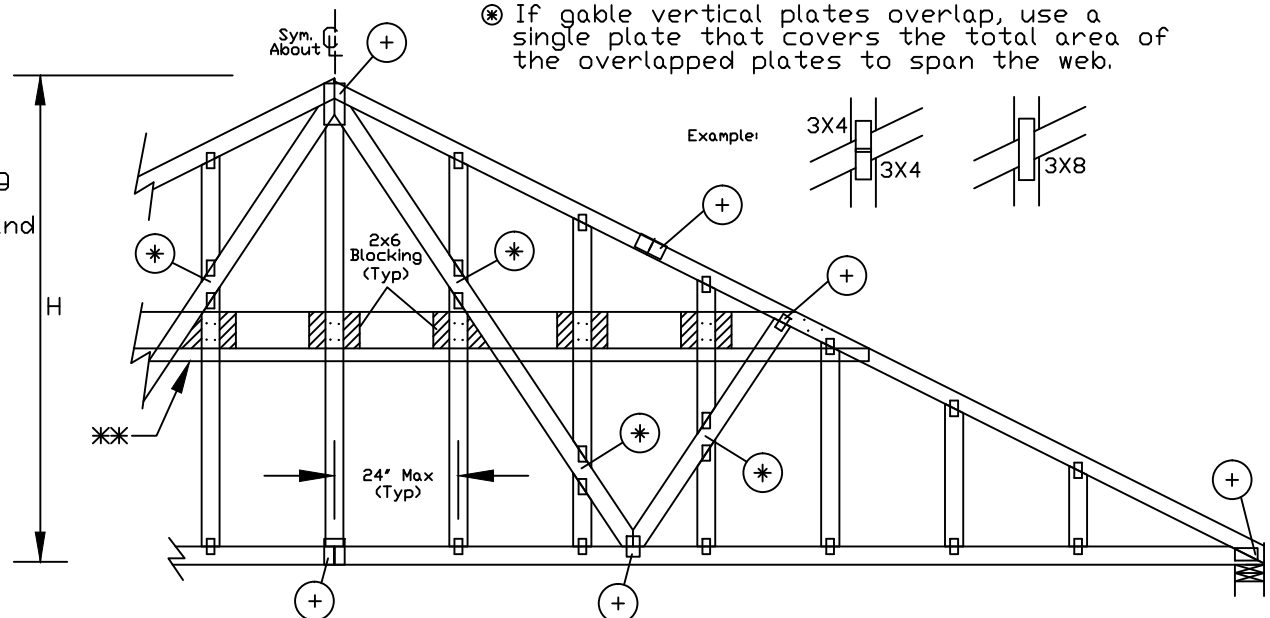
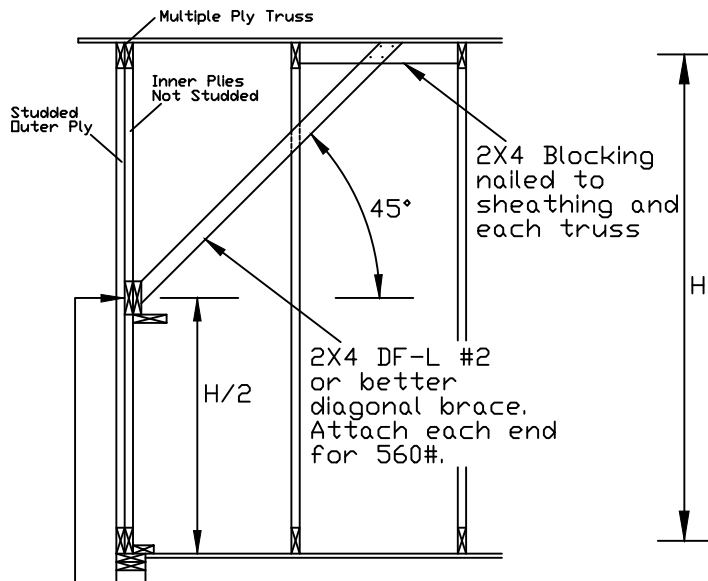

2x6 #2 blocking and stiffback. Blocking is cut to fit between webs of inner plies, repeat for each ply. Attach blocking to each stud w/ (4) 10d box or gun (0.128" X 3", min.) nails. Repeat for each ply. Attach stiffback to blocking and chords w/ (4) 10d box or gun (0.128" X 3", min.) nails at each stud location.

WARNING: READ AND FOLLOW ALL NOTES ON THIS DRAWING! FURNISH THIS DRAWING TO ALL CONTRACTORS INCLUDING THE INSTALLERS.

Trusses require extreme care in fabricating, handling, shipping, installing and bracing. Refer to and follow the latest edition of BCSI (Building Component Safety Information, by TPI and SBCA) for safety practices prior to performing these functions. Installers shall provide temporary bracing per BCSI. Unless noted otherwise, top chord shall have properly attached structural sheathing and bottom chord shall have a properly attached rigid ceiling. Locations shown for permanent lateral restraint of webs of truss and position as shown above and on the Joint Details, unless noted otherwise. Refer to drawings 160A-Z for standard plate positions.

Alpine, a division of ITW Building Components Group Inc. shall not be responsible for any deviation from this drawing, any failure to build the truss in conformance with ANSI/TPI 1, or for handling, shipping, installation & bracing of trusses.

A seal on this drawing or cover page listing this drawing, indicates acceptance of professional engineering responsibility solely for the design shown. The suitability and use of this drawing for any structure is the responsibility of the Building Designer per ANSI/TPI 1 Sec.2.

For more information see this Job's general notes page and these web sites:
ALPINE: www.alpineitw.com; TPI: www.tpinst.org; SBCA: www.sbcacomponents.com; ICC: www.iccsafe.org



514 Earth City Expressway
Suite 242
Earth City, MO 63045

REF GE WHALER
DATE 08/31/2020
DRWG G1P12030160920